

HIGH PROFILE

TOP VIEW

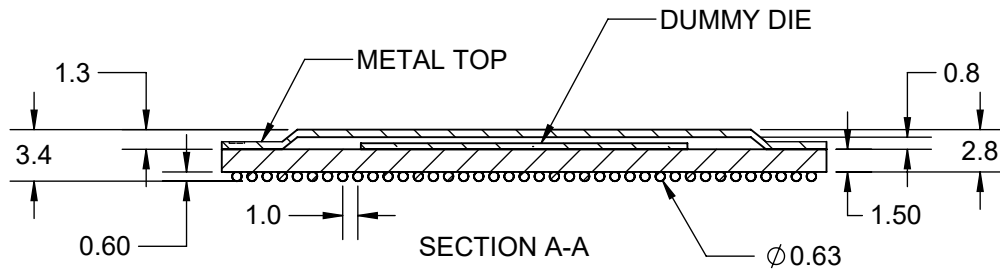

BALL VIEW

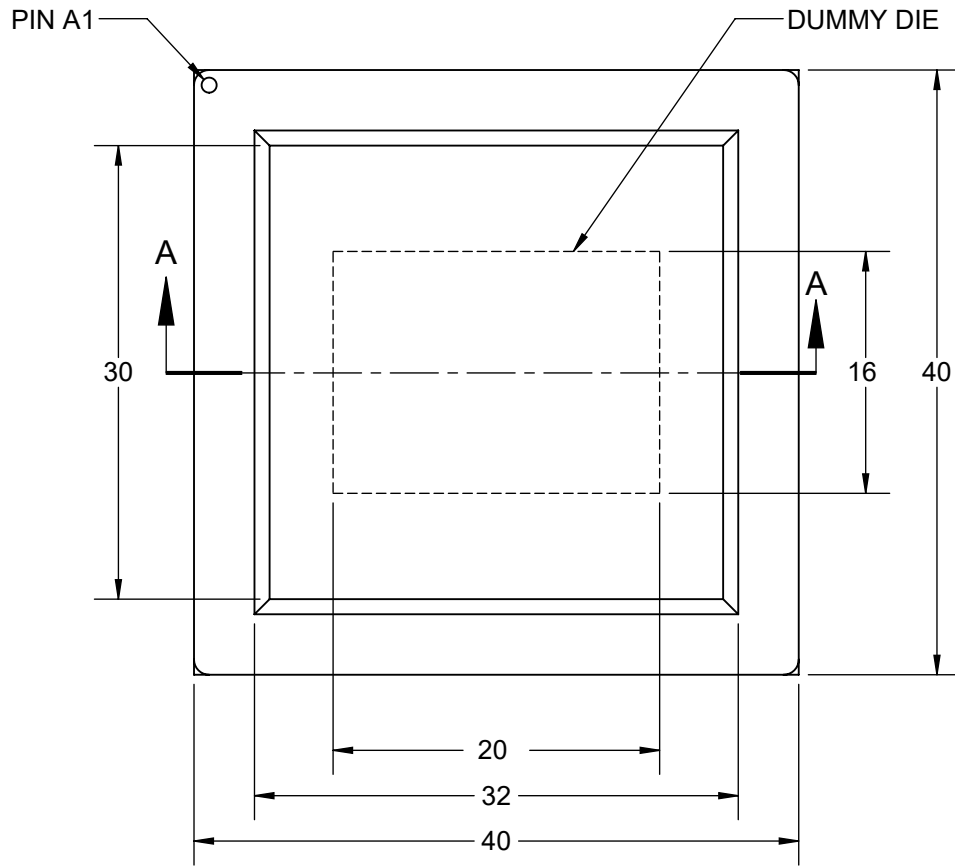
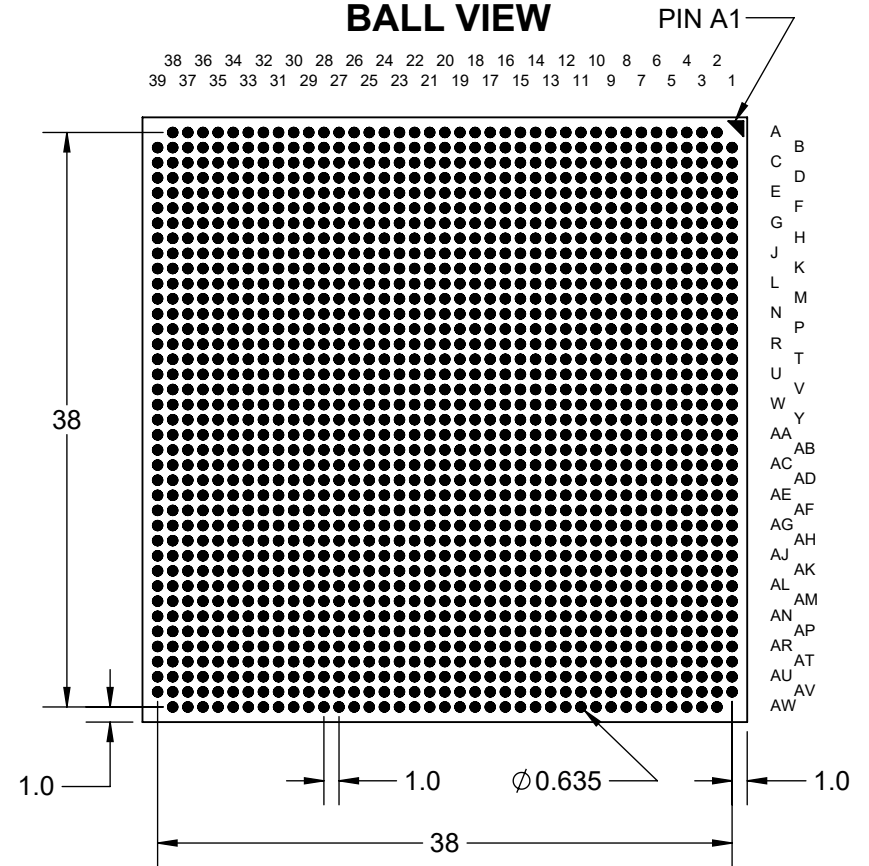

Notes: (Unless Otherwise Specified).

- 1) ALL DIMENSIONS ARE IN MM.
- 2) SOLDER BALL ALLOY: SEE PART NUMBER TABLE.
- 3) BALL DIAMETER (BEFORE REFLOW) 0.635mm.
- 4) SOLDER MASK DEFINED PAD OPENING: 0.508mm [20mil].
- 5) PAD Cu DIAMETER: 0.635mm [25MIL].
- 6) DUMMY DIE. Si (SILICON).
- 7) DAISY CHAIN PATTERN (SEE PAGE 2).
- 8) MSL-3 RECOMMENDED BAKING 24 HOURS @ 125°C TO REMOVE MOISTURE PRIOR TO SOLDERING TO PC BOARD.

PART NUMBER TABLE

PART NUMBER	BALL METAL	BALL ALLOY	RoHS	Si DIE
SBGA1517T1.0C-DC397HD	Sn96.5/Ag3.0/Cu0.5	SAC305	YES	YES
SBGA1517T1.0-DC397HD	Sn63/Pb37	Sn63	NO	YES

APPROVALS	DATE				
DRAWN T. Au	3/26/2024				
ENG M. Hart	3/26/2024	TITLE SBGA1517T1.0-DC397HD DAISY CHAIN DUMMY			
MFG		SCALE	SIZE	DRAWING NO.	REV
QA		2:1	A	513976	A
CUST		DO NOT SCALE DRAWING			SHEET 1 OF 7
REVISED					

BALL VIEW

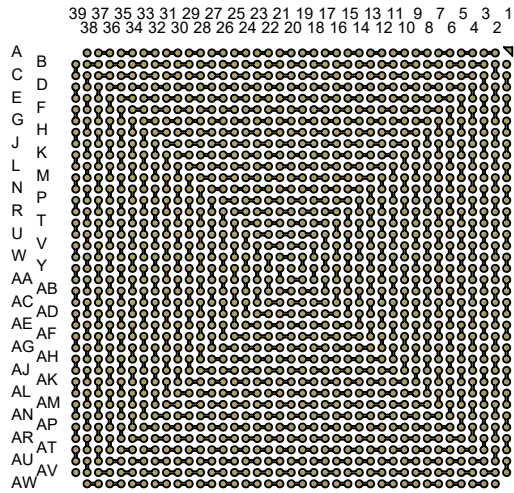

BOTTOM SIDE (TOP X-RAY VIEW)

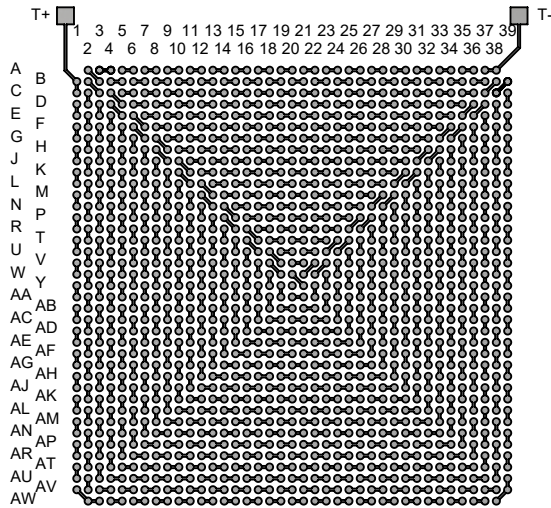
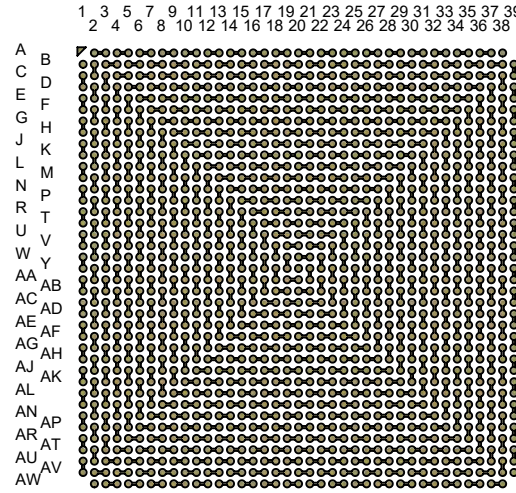

TEST VEHICLE BOARD

Notes:

- PCB BOARD DIMENSIONS ARE PRESENTED ONLY AS A GUIDELINE
- DESIGNERS SHOULD USE THEIR OWN KNOWLEDGE WHEN DESIGNING THE PCB.
- PCB Cu BALL PAD DIAMETER: 0.635mm [25mil].
- PCB DAISY CHAIN TRACING LINE WIDTH: 0.203mm [8mil].
- SMD (SOLDER MASK DEFINED) PAD OPENING: 0.508mm [20mil].

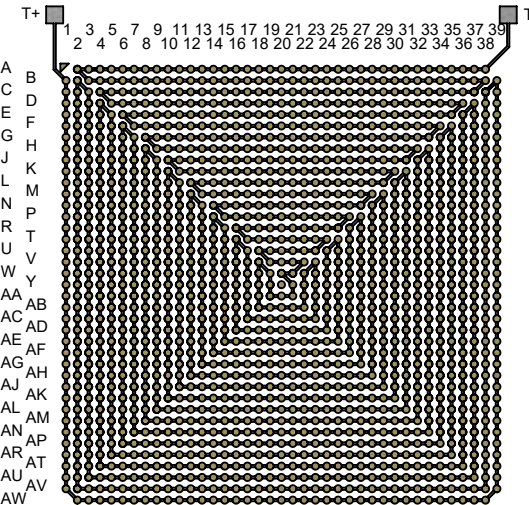

AFTER MOUNTING

TopLine®			
TITLE SBGA1517T1.0-DC397HD DAISY CHAIN DUMMY			
SCALE 2:1	SIZE A	DRAWING NO. 513976	REV A
DO NOT SCALE DRAWING			SHEET 2 OF 7

BALL VIEW

39 38 37 36 35 34 33 32 31 30 29 28 27 26 25 24 23 22 21 20 19 18 17 16 15 14 13 12 11 10 9 8 7 6 5 4 3 2 1

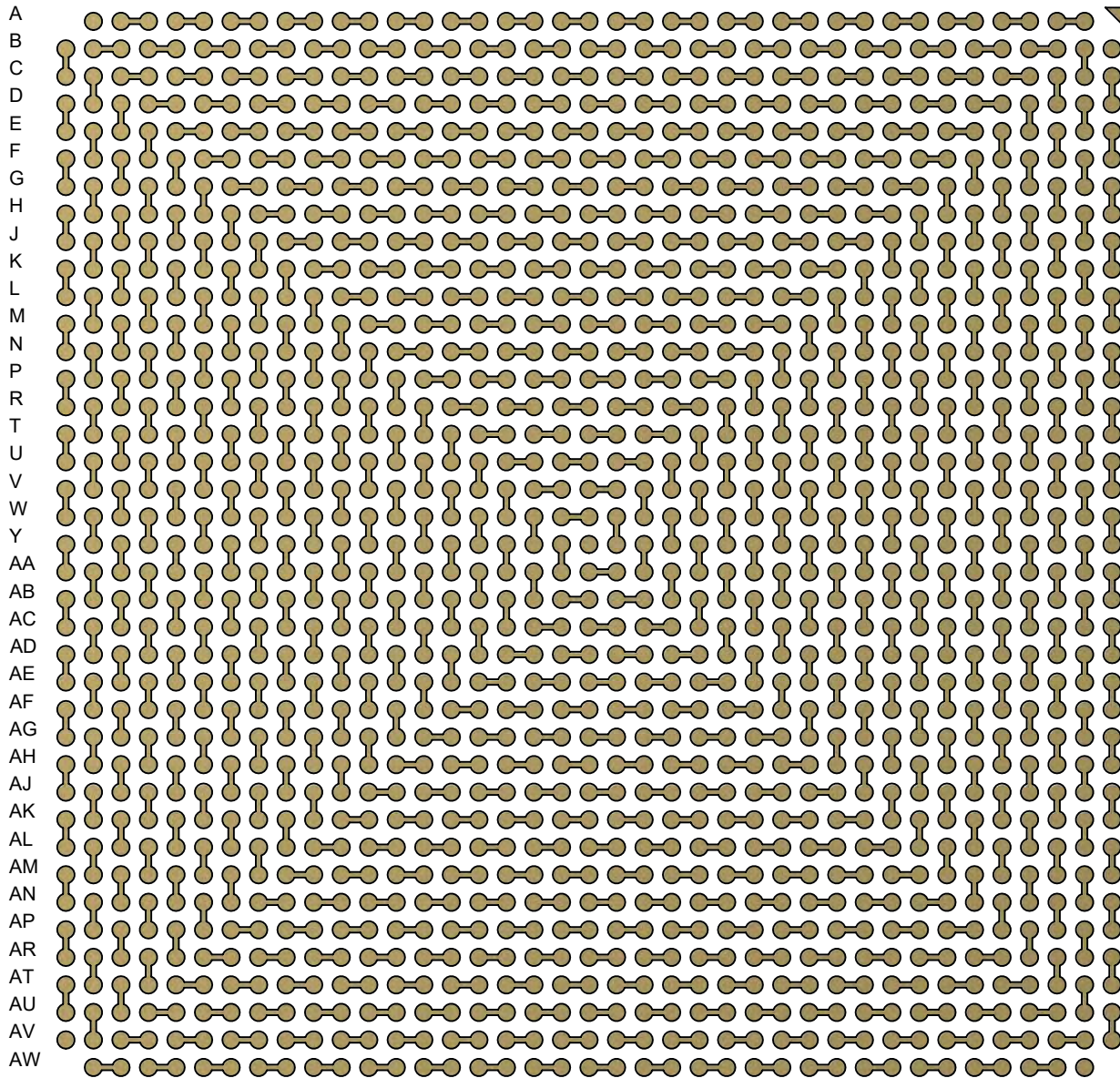

TopLine®

TITLE SBGA1517T1.0-DC397HD
DAISY CHAIN DUMMY

SCALE 2:1	SIZE A	DRAWING NO. 513976	REV A
--------------	-----------	-----------------------	----------

BOTTOM SIDE (TOP X-RAY VIEW)

1 2 3 4 5 6 7 8 9 10 11 12 13 14 15 16 17 18 19 20 21 22 23 24 25 26 27 28 29 30 31 32 33 34 35 36 37 38 39

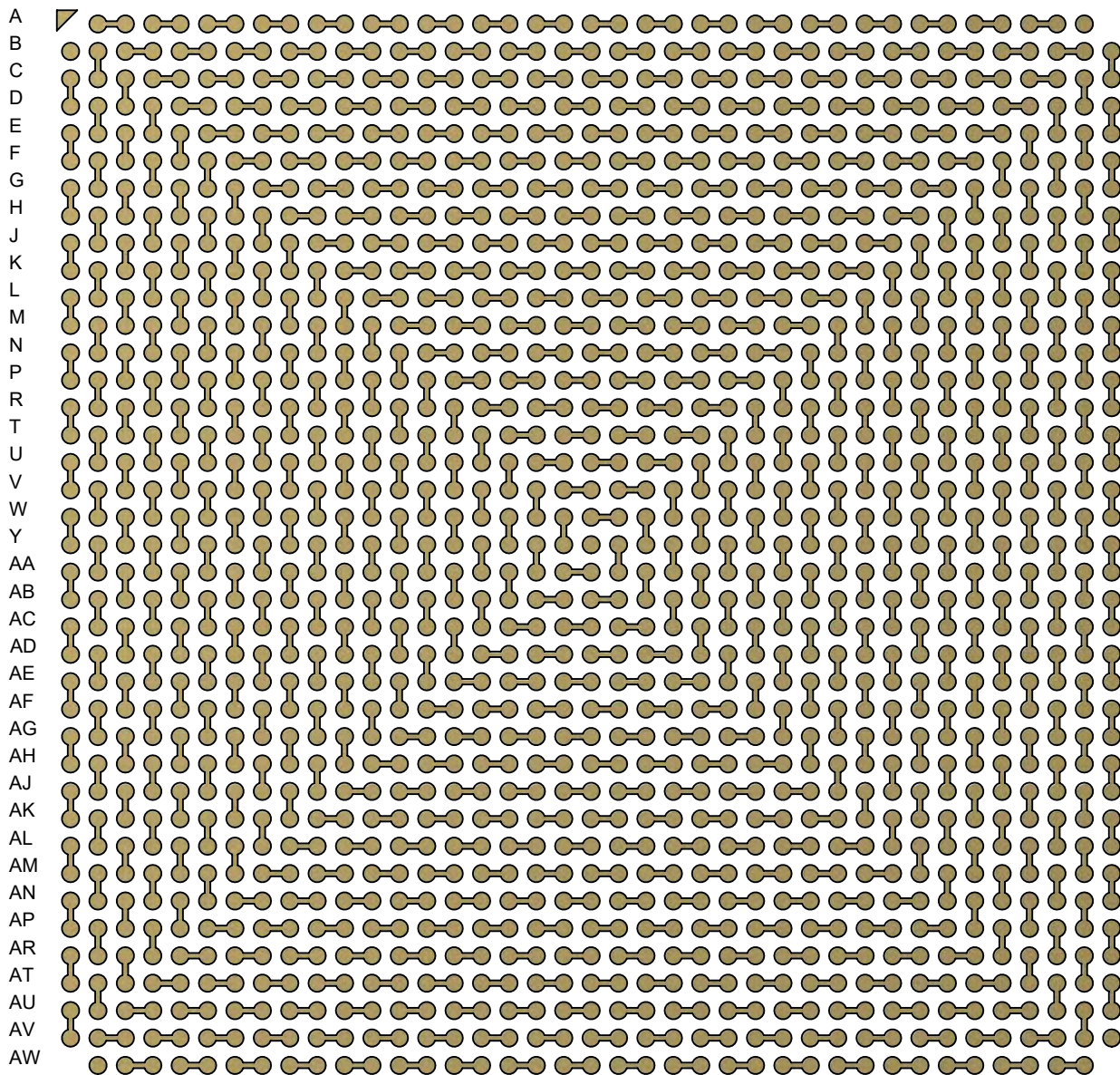

TopLine [®]			
TITLE		SBGA1517T1.0-DC397HD DAISY CHAIN DUMMY	
SCALE	SIZE	DRAWING NO.	REV
2:1	A	513976	A
DO NOT SCALE DRAWING			SHEET 4 OF 7

HEAT SPREADER

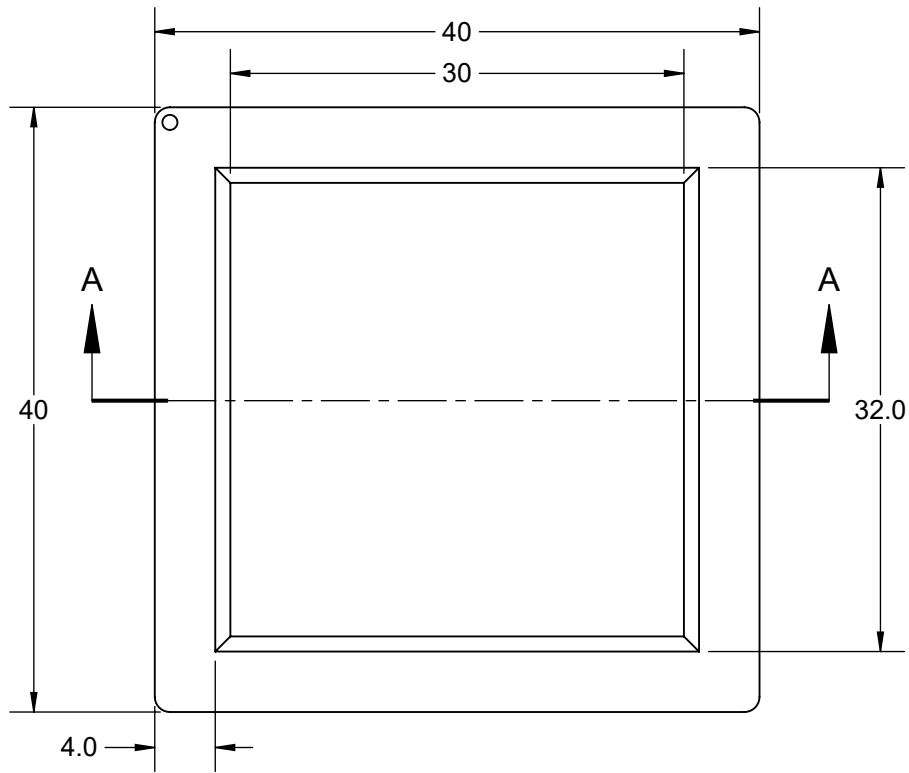

TOP

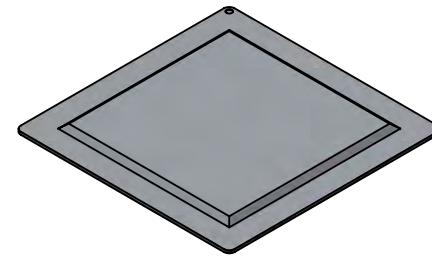

MODEL

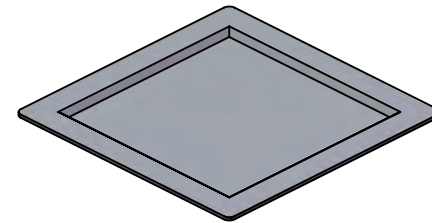

CAVITY

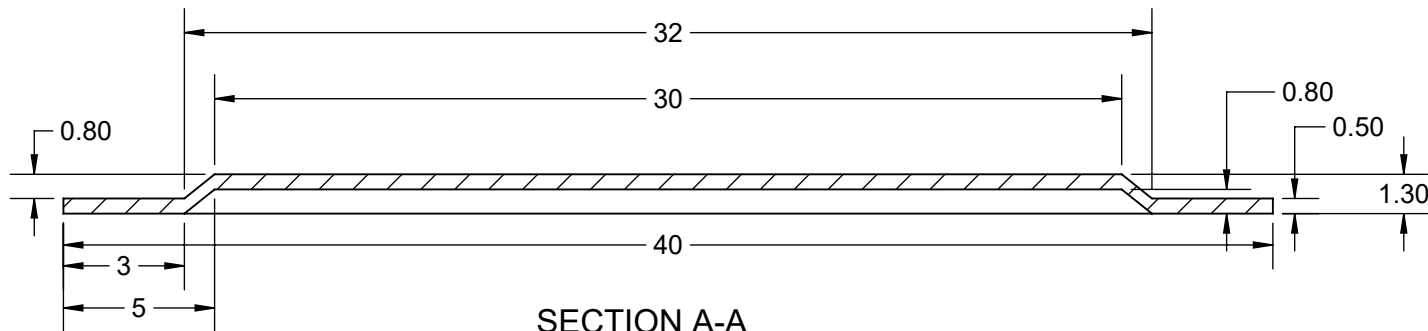

SECTION A-A
SCALE 4 : 1

TopLine[®]

TITLE SBGA1517T1.0-DC397HD
DAISY CHAIN DUMMY

SCALE 3:2	SIZE A	DRAWING NO. 513976	REV A
--------------	-----------	-----------------------	----------

DO NOT SCALE DRAWING

SHEET 5 OF 7

MODEL

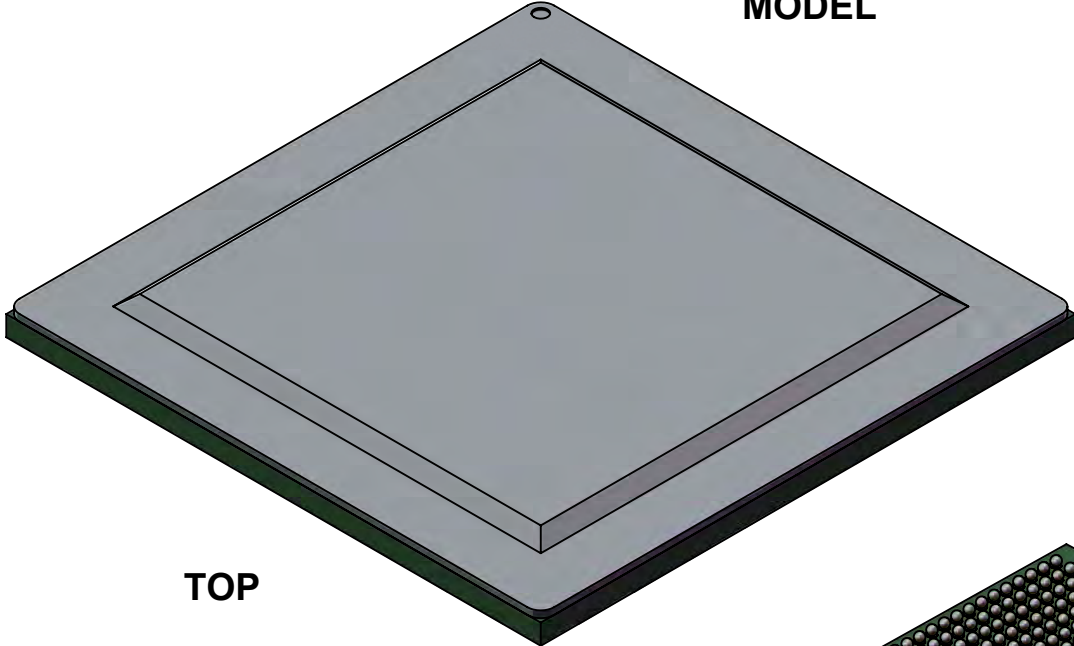

TOP

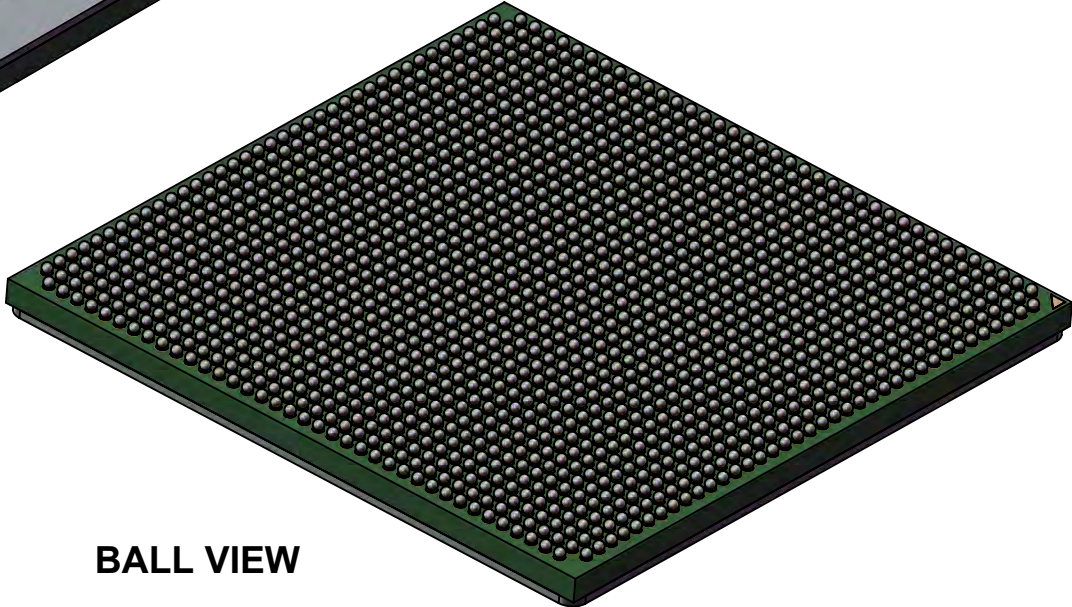

BALL VIEW

TopLine[®]

TITLE SBGA1517T1.0-DC397HD
DAISY CHAIN DUMMY

SCALE 2:1	SIZE A	DRAWING NO. 513976	REV A
--------------	-----------	-----------------------	----------

DO NOT SCALE DRAWING SHEET 6 OF 7

**BOTTOM SOLDERMASK
(RIGHT READING)**

39 38 37 36 35 34 33 32 31 30 29 28 27 26 25 24 23 22 21 20 19 18 17 16 15 14 13 12 11 10 9 8 7 6 5 4 3 2 1

A
B
C
D
E
F
G
H
J
K
L
M
N
P
R
T
U
V
W
Y
AA
AB
AC
AD
AE
AF
AG
AH
AJ
AK
AL
AM
AN
AP
AR
AT
AU
AV
AW

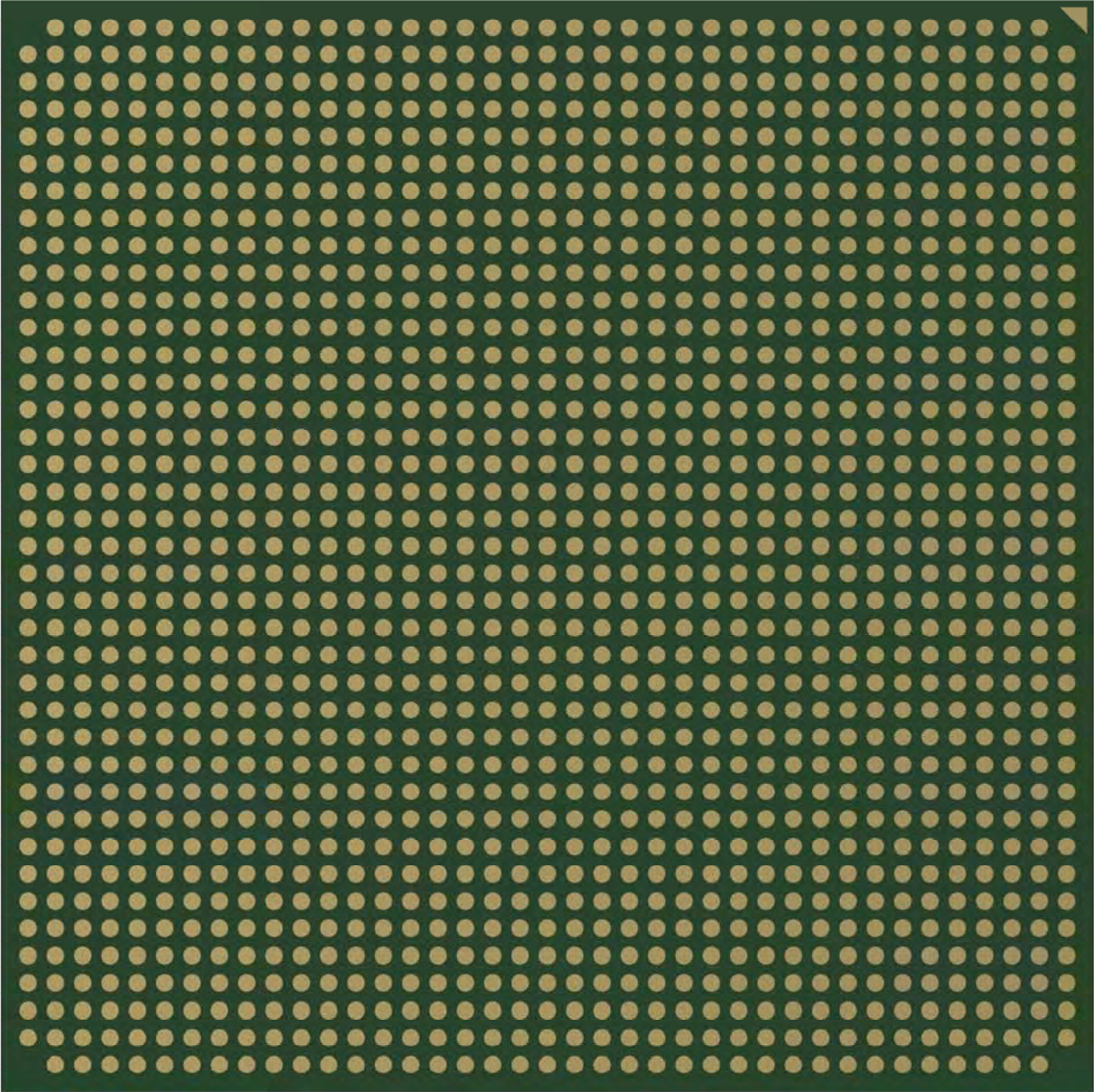

TopLine®			
TITLE SBGA1517T1.0-DC397HD DAISY CHAIN DUMMY			
SCALE 2:1	SIZE A	DRAWING NO. 513976	REV A
DO NOT SCALE DRAWING			SHEET 7 OF 7